

Dimensions

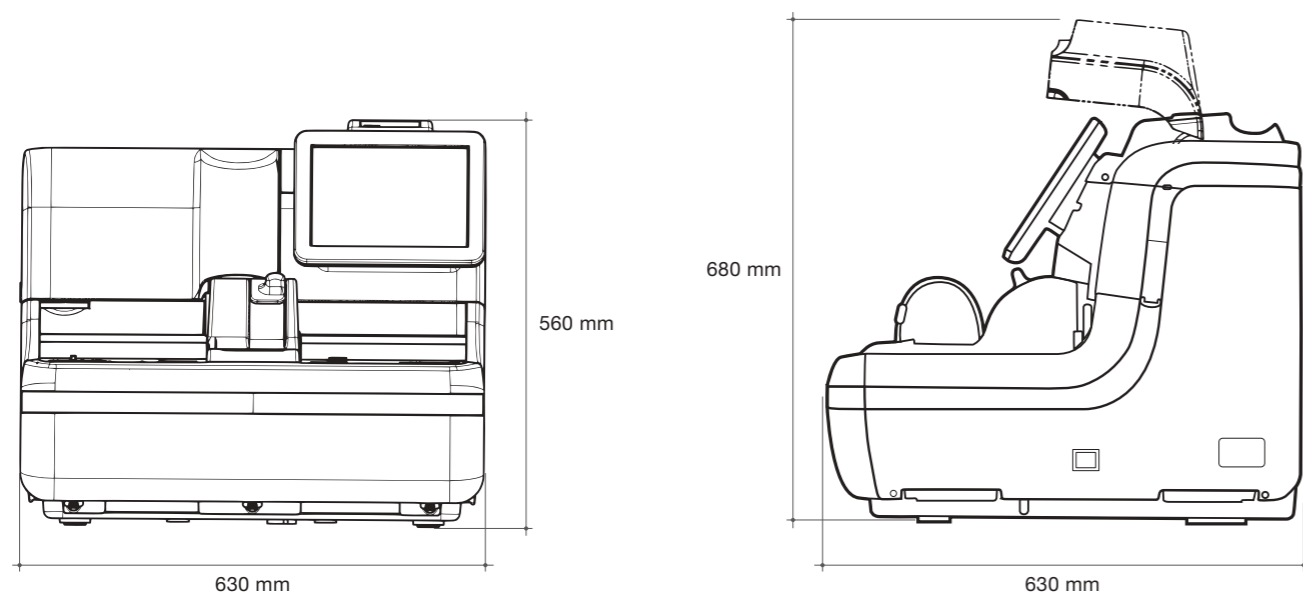

Specifications

Product Name	OC-SENSOR PLEDIA
Principle	Latex agglutination immunoturbidimetry
Operation Speed	320 tests/hour
Sample Loading Capacity	10-sample rack × 20 *200-sample rack-tray (optional)
STAT Sample	Up to 10 samples simultaneously
Sample Dilution	15 times and 250 times
Reaction Cuvette	Semi-disposable acrylic cuvette (11 serial cells × 5 cuvettes) Automatic cuvette cleaning with wash solution and purified water
Sampling System	Drawn up by reagent nozzle (Liquid surface detection, automatic cleaning with wash solution and purified water)
Reagent Dispense	Drawn up by reagent nozzle (Liquid surface detection, automatic cleaning with purified water)
Mixing System	By spinning mixer (automatic cleaning with wash solution and purified water)
Thermostatic System	Reaction wheel: air bath block heater, Reagent housing: block heater
Light Source	LED (wavelength 660 nm)
Light Detector	Photodiode
Data Input	Color LCD touch panel (10.5 inches)
Memory Capacity	100,000 test results
Data Output	Built-in thermal printer, RS-232C, USB, LAN connection
Barcodes	Rack barcode, sample barcode, reagent barcode, two-dimensional barcode (optional)
Dimensions	W630mm × D630mm × H560mm
Weight	58kg
Power Required	AC100-240V 50/60Hz, 500VA
Applicable standards and laws	The PMDAct, CE

Reagents & Consumables

*All liquids



OC-SENSOR DIANA Latex Reagent / Buffer



OC-Control LV1 / OC-Control LV2
OC-Calibrator 2 kit

Please use this product after reading the Operation Manual carefully.

Distributed by:
FIT@mastgrp.com
0151 - 933 7277



EIKEN CHEMICAL CO., LTD.
4-19-9, Taito, Taito-ku, Tokyo 110-8408, Japan
<http://www.eiken.co.jp/en>

CE
3074 AIB1
June 2015

OC-SENSOR PLEDIA

FIT(iFOBT) automation



EIKEN CHEMICAL CO., LTD.

FEATURES & PERFORMANCE

New Features and Enhanced Performance

High throughput-sampling

Improved processing speed, increased sampling loading capacity



Large capacity

Capable of analysing 320 samples an hour.



Set reagents

With the number of reagent slots increased from two to three, PLEDIA is more efficient for high throughput population screening.



200 samples

Up to 200 samples can be loaded at a time. Operation with a tray is also available. * The tray system is optional.

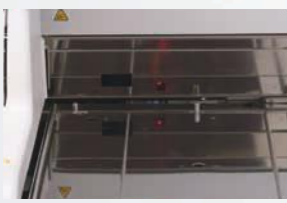

Automated rack recognition sensor

Sample rack recognition function automatically starts analysis as the rack is set.

Advanced usability

Improved screen operability



User-friendly touch panel

10.5 inch LCD touch panel. The adjustable display angle improves visibility.

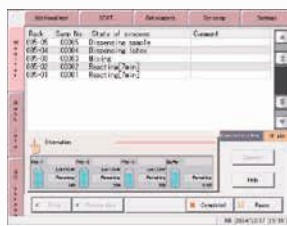

Real-time information

Real-time information is available, including information on reagents and sample processing time.

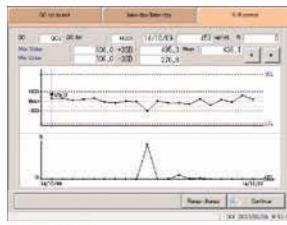

Quality control function

X-R control screen, CV auto calculation, etc. Massive QC function is available.



Complete automation system



Full automation

Equipped with the capability for automatic startup, start, and shut down.



Automatic identification of measurement modes

Barcodes on racks enable the measurement mode to be identified automatically.



After completing an analysis

Retest racks enable simple re-testing. With a dilute rack, 15-times and/or 250-times dilution (s) is automatically performed.



Prozone recognition

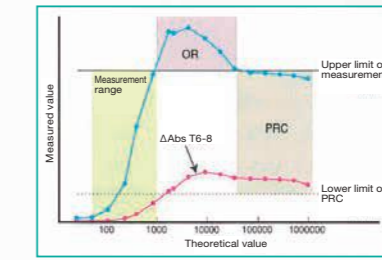

If the Δ Abs at the T6-8 photometric point of samples under the upper limit of measurement is above the lower limit of the PRC, the sample is recognized as within the prozone (PRC region).

Prozone of highly-concentrated samples is checked through the Primary Rate Check (PRC) method.

Squeeze-up system

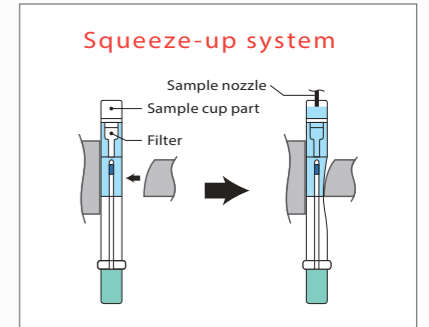
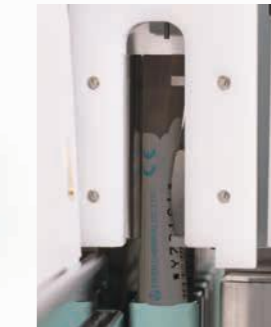

As sampling bottle is squeezed, samples are filtered into the sample cup part, and then drawn by the sampling nozzle.